

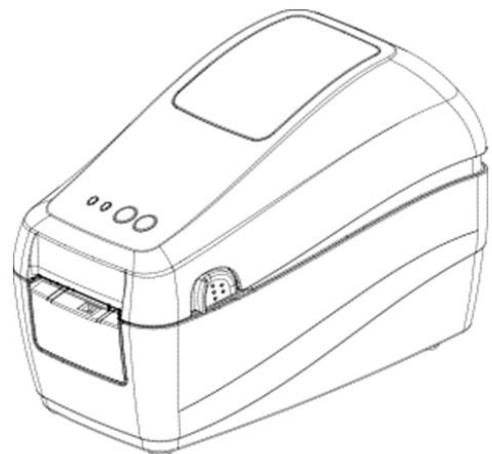

GS-2208D/GS-3205D Series

**DIRECT THERMAL
THERMAL LABEL PRINTER**

USER'S MANUAL



Agency Compliance and Approvals



EN 55032, Class A
EN 55024

This is a class A product. In a domestic environment this product may cause radio interference in which case the user may be required to take adequate measures.



FCC part 15B, Class A

This equipment has been tested and found to comply with the limits for a Class A digital device, pursuant to Part 15 of the FCC Rules. These limits are designed to provide reasonable protection against harmful interference when the equipment is operated in a commercial environment. This equipment generates, uses, and can radiate radio frequency energy and, if not installed and used in accordance with the manufacturer's instruction manual, may cause harmful interference with radio communications. Operation of this equipment in a residential area is likely to cause harmful interference, in which case you will be required to correct the interference at your own expense.

WARNING

This is a Class A product. In a domestic environment this product may cause radio interference in which case the user may be required to take adequate measures.

Environmental protection



Do not dispose of this product in an unsorted public trash can. You should recycle this product according to local regulations.

For more information, please browse our website : <http://www.gainscha.com.tw>

Copyright Information

The copyright in this manual, the software and firmware in the printer described therein are owned by Gainscha All rights reserved.

All other trademarks are the property of their respective owners.

Information in this document is subject to change without notice and does not represent a commitment on the part of Gainscha No part of this manual may be reproduced or transmitted in any form or by any means, for any purpose other than the purchaser's personal use, without the expressed written permission of Gainscha.

Contents

1. Introduction.....	5
1.1 Product Introduction.....	5
1.2 Product Features.....	7
1.2.1 Printer Standard Features.....	7
2. Operations Overview.....	9
2.1 Unpacking and Inspection.....	9
2.2 Printer Overview.....	10
2.2.1 Front View.....	10
2.2.2 Interior View.....	10
2.2.3 Front View.....	11
2.2.4 Rear View.....	11
3. Setup.....	12
3.1 Setting up the Printer.....	12
3.2 Install Printer Driver.....	13

3.3 Loading the Media.....	16
3.3.1 Loading the Roll Labels.....	16
3.3.2 print media loading diagram	16
4. LED and Button Functions	17
4.1 LED Indicator	17
4.2 Regular Button Functions.....	18
4.3 Power-on Utilities	19
5. PrinterUtility	20
5.1 Start the PrinterUtility	20
5.2 Printer Function	21
6. Troubleshooting	22
6.1 Common Problems.....	22
7. Maintenance.....	24
8. Revise History	25

1. Introduction

1.1 Product Introduction

Thank you for purchasing Gainscha bar code printer. Although the printer has a small footprint, it delivers reliable, superior performance.

This printer provides direct thermal printing at user selectable speed of: 2.0 · 3.0 · 4.0 · 5.0 · 6.0 · 7.0 or 8.0 ips for 203 dpi; 2.0 · 3.0 · 4.0 or 5.0 ips for 300 dpi. It accepts roll feed, die-cut, and fan-fold media with gap or black mark. All common bar codes formats are available. Fonts and bar codes can be printed in 4 directions, 8 different alphanumeric bitmap fonts and built-in scalable font capability. You will enjoy trouble free, high throughput for printing labels with this printer.

- Applications
 - Manufacturing & Warehousing
 - Work in Progress
 - Item Labels
 - Instruction labels
 - Agency labels
 - Healthcare
 - Patient Identification
 - Pharmacy
 - Specimen Identification
 - Parcel Post
 - Shipping/ Receiving Labels
 - Small Office/ Home Office
 - Retail Marking
 - Price tags
 - Shelf labels
 - Jewelry tags

1.2 Product Features

1.2.1 Printer Standard Features

PRINTER MODEL	GS-2208D	GS-3205D	GS-2208DM	GS-3205DM
Level	Economic	Economic	Empower	Empower
Resolution	8dots/mm (203DPI)	12dots/mm (300DPI)	8dots/mm (203DPI)	12dots/mm (300DPI)
Printing Method	Direct Thermal			
Max. print speed	203.2mm(8")/ second	127mm(5")/ second	203.2mm(8")/ second	127mm(5")/ second
Max. print width	54 mm (2.13")	54 mm (2.13")	54 mm (2.13")	54 mm (2.13")
Max. print length	2,794 mm (110")	1,016 mm (40")	25,400 mm (1000")	11,430 mm (450")
CPU specifications	400 MHZ, 32 bits, ARM9			
Memory RAM	64 MB SDRAM		64 MB SDRAM	
Memory ROM	32 MB Flash Memory		128 MB Flash Memory	
Interface	<ul style="list-style-type: none"> ➤ USB 2.0 High Speed 480Mbps ➤ USB Host 2.0, for scanner or PC keyboard ➤ Internal Ethernet 10/100Mbps 		<ul style="list-style-type: none"> ➤ USB 2.0 High Speed 480Mbps ➤ USB Host 2.0, for scanner or PC keyboard ➤ Internal Ethernet 10/100Mbps 	
Real Time Clock	N/A		Standard (CR2032 Battery Install)	
Buzzer	N/A		Standard	
Sensors	Head open sensor, Reflective sensor (moveable), Transmissive sensor (Fixed), Front-Reflective sensor			
Power	External universal switching power supply Input: AC 100-240V, 2.5A, 50-60Hz, Output: DC 24V, 2.5A, 60W			
User Interface	1 power switch, 2 buttons (Feed & Pause), 2 LEDs (Online, Error status)			
Internal fonts	<ul style="list-style-type: none"> ➤ 8 alpha-numeric bitmap fonts ➤ True type font engine (need download scalable font file) 			

1D Baroced	Code 11, Code 39, Code 93, Code 128 (subsets A, B, C), UPC-A, UPC-E, UCC-128, Codabar, EAN/JAN-8, EAN/JAN-13, Interleaved 2 of 5, ITF14, MSI Pleassy, PostCode, Telepen			
2D Barcode	QR Code, Micro QR Code, PDF417, Micro PDF417, MaxiCode, Aztec Code, Data Matrix			
Rotation	Font and barcode support 0, 90, 180, 270 degree			
Printer language	Compatible to TSPL, ZPL, ZPL II			
Media type	Continuous, die-cut, black mark, fan-fold, notched (outside wound)			
Media width	18 ~ 65mm (0.7" ~ 2.55")			
Media thickness	0.06 ~ 0.19mm(2.36 ~ 7.48mil)			
Media core diameter	25.4 mm (1")			
Label roll capacity	111.7 mm (4.4") OD			
Label length	5 ~ 2,794 mm (0.2" ~ 110")	5 ~ 1,016 mm (0.2" ~ 40")	5 ~ 25,400 mm (0.2" ~ 1000")	5 ~ 11,430 mm (0.2" ~ 450")
Physical dimension	129mm(W)x165.3mm(H)x244.3mm(D)			
Enclosure	ABS plastic			
Safety certification	FCC Class A, CE Class A, CCC, BIS, CB			
Environment condition	Operation: 5 ~ 40°C, 25 ~ 85% non-condensing Storage: -40 ~ 60°C, 10 ~ 90% non-condensing			
Environmental concern	Comply with RoHS, REACH, WEEE			

2. Operations Overview

2.1 Unpacking and Inspection

This printer has been specially packaged to withstand damage during shipping. Please carefully inspect the packaging and printer upon receiving the bar code printer. Please retain the packaging materials in case you need to reship the printer.

Unpacking the printer, the following items are included in the carton.

- One printer unit
- One quick installation guide
- One power cord
- One external universal switching power supply
- One USB interface cable
- One core coated art paper roll
- One Windows labeling software/Windows driver CD disk
- One label roll holder

If any parts are missing, please contact the Customer Service Department of your purchased reseller or distributor.

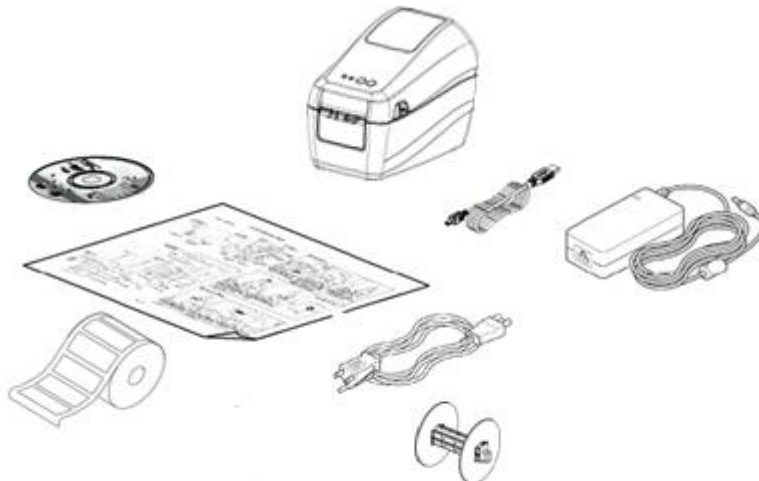

2.2 Printer Overview

2.2.1 Front View



1. ONLINE indicator
2. ERROR indicator
3. PAUSE button
4. FEED button
5. WINDOWS (The windows can look through)

2.2.2 Interior View

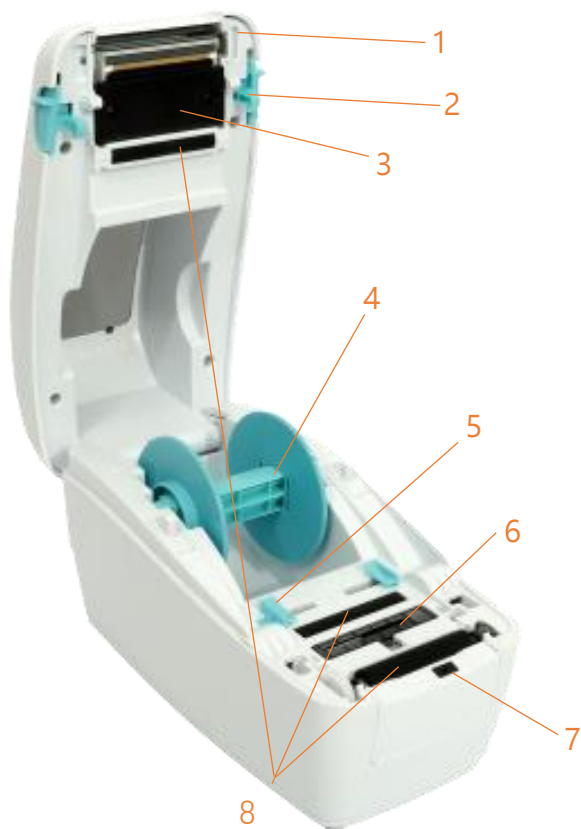

1. Printer top cover
2. Top cover open tab
3. Gap transmitter
4. Media holder
5. Media guide
6. Black mark paper sensor \ Gap receiver
7. Front-end label return sensor
8. Platen roller

2.2.3 Front View



1
2

1. Paper tearing edge
2. Front bezel

2.2.4 Rear View



1 2 3 4

1. Power jack socket
2. USB interface
3. USB host (For HID keyboard or scanner)
4. RJ-45 Ethernet Street 10 / 100M bps
5. Power switch

3. Setup

3.1 Setting up the Printer

1. Place the printer on a flat, secure surface.
2. Make sure the power switch is set to "off".
3. Connect the printer to the computer with the provided USB cable.
4. Plug the power cord into the AC power cord socket at the rear of the printer, and then plug the power cord into a properly grounded power outlet.

Note: Please switch OFF printer power switch prior to plug in the power cord to printer power jack.



3.2 Install Printer Driver

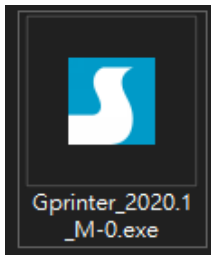

<p>1. Read the license agreement, click [I accept the terms in license agreement], and click [Next].</p>	<p>2. Select a installation directory and click [Next].</p>
<p>3. Click [Finish].</p>	<p>4. Go to installation process, please click [Install Printer Driver], and then click [Next].</p>

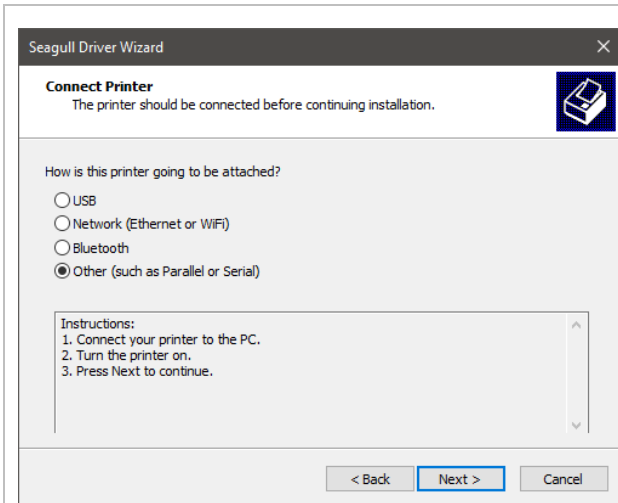

5. Click [Other] and click [Next].

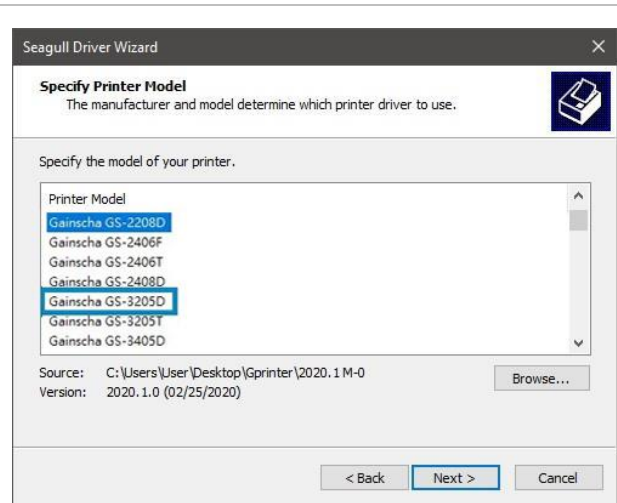

6. Select printer model name, click to install and click [Next].

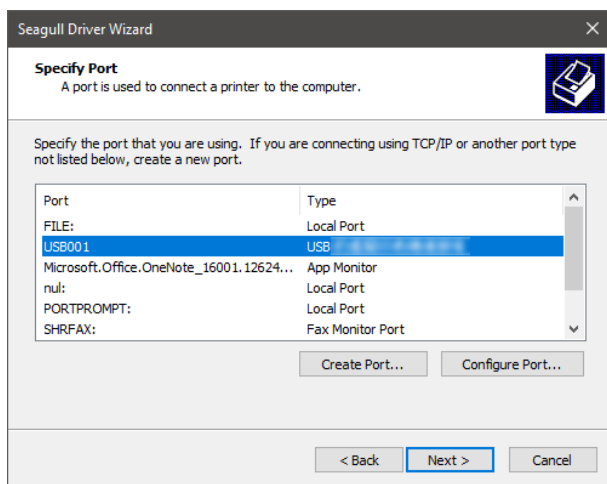

7. Please use a USB cable to connect the printer to the computer, click the corresponding USB interface, and click [Next].

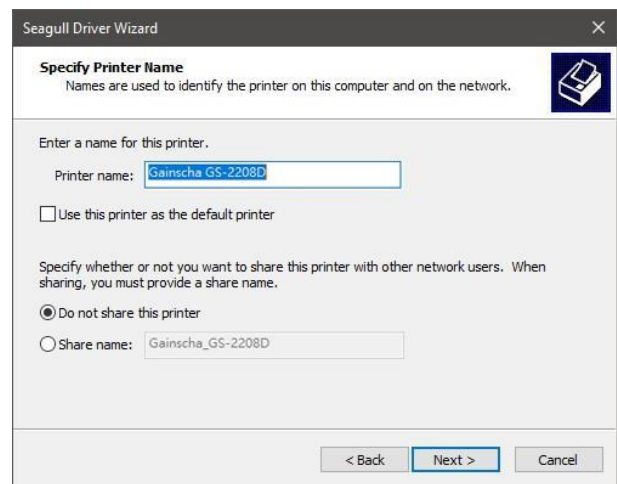

8. Change the printer name as per need, and click [Next].

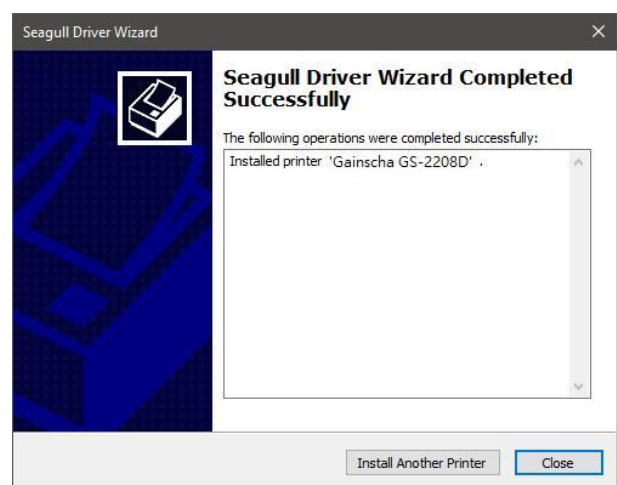

9. Click [Finish].

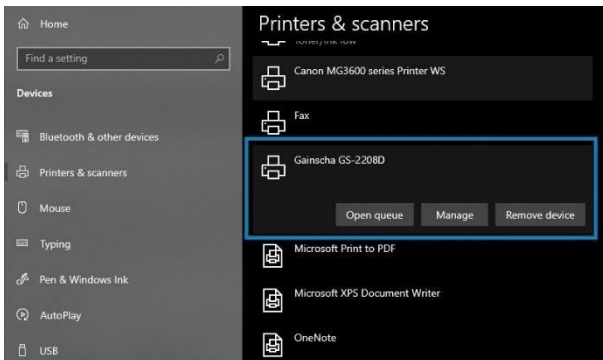

10. The installation is complete, please click [Close].

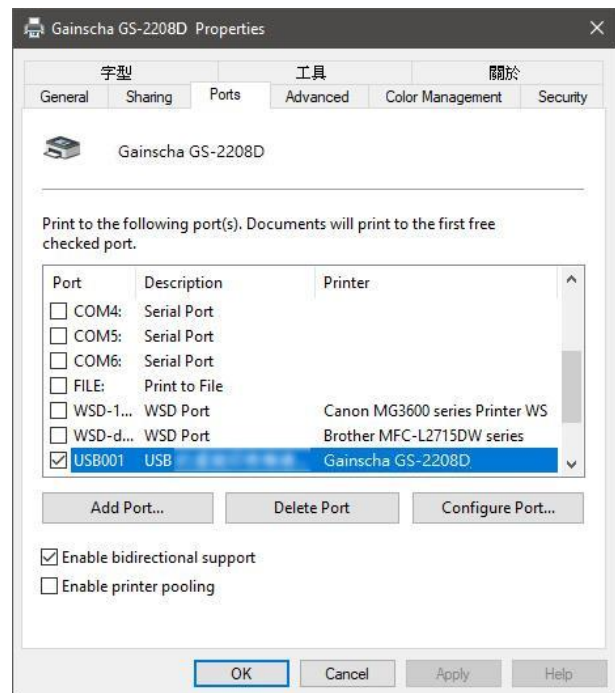

11. Users can check whether the installation is completed through the following ways:

- a. If Windows 10, check from [Windows Settings] → [Devices] → [Printers and Scanners].
- b. Check from [Control Panel] → [Devices and Printers].

12. Users can change printer interface through the following ways:

- a. In Windows 10, [Windows Settings] → [Printers and Scanners] → [Devices] → select the corresponding printer model → [Management] → [Printer Content] → [Port] to change different USB port / COM port as per need.
- b. From [Control Panel] → [Devices and Printers] → select the corresponding printer model → right-click → [Printer Content] → [Port] to modify it.

3.3 Loading the Media

3.3.1 Loading the Roll Labels

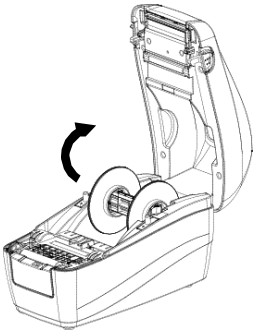
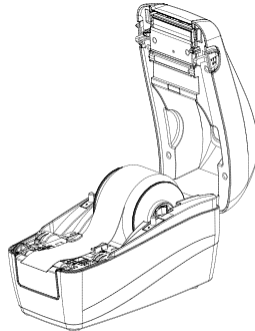



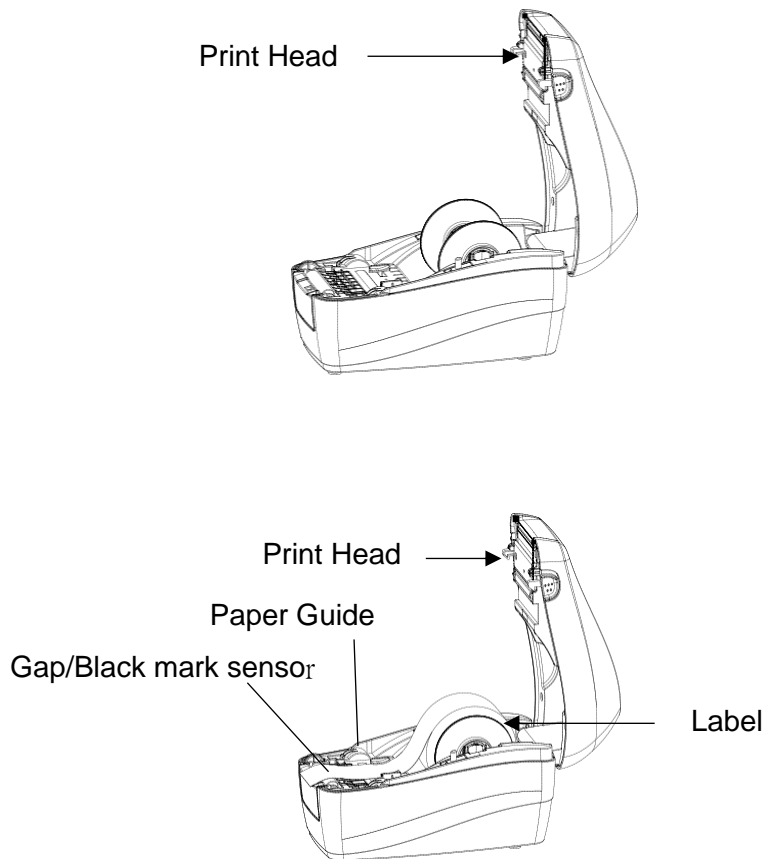













	
<p>1. Press two buttons on printer two sides to lift and open the cover.</p>	<p>2. Load print media into the printer; adjust the paper guide to be same width of print media.</p>

3.3.2 print media loading diagram



4. LED and Button Functions

4.1 LED Indicator

Event	Description	Status lights 1	Status lights 2	Beep
Direct thermal mode ready	Blue(ONLINE) solid, the device is ready to use.			
Open cover	When the cover is open, a beep sound will be made, and Blue(ONLINE), and Red (ERROR) will flash.			
FEED	Press the FEED button to print as per demand, Blue(ONLINE) will flash.			
Out of paper	When out of paper, a beep sound will be made, and Red(ERROR) flash.			
Page setup error	When the page setup error, a beep sound will be made, and Red(ERROR) solid Blue(ONLINE) flash.			
Print head overheated	When print head overheated, a beep sound will be made, and Blue(ONLINE)and Red(ERROR) alternately flash.			
Other errors	When other errors, a beep sound will be made, and Red(ERROR) flash.			



4.2 Regular Button Functions

This printer has two buttons for feed, pause or cancel errors. There are different functions









in different modes, as shown in the following form:

Button	Printer status	Function	Description
Feed button	Ready	Feed	When the printer is ready (Blue LED ON), press this button once, and the label will advance to the front of the next label
Feed button	Wait for push button to print	Print next	When the button Demand function is activated, the printer will stop after printing and wait for the user to press this button before printing the next label.
Pause button	Print mode	Pause	When the printer is printing continuously, pressing the PAUSE button will pause printing. The power indicator is blue flashing. Just press the button again, and the print job returns to normal.
Pause button	Error occurred	Cancel error	When the error RED is on, press the PAUSE button once, the printer will cancel the error and resume printing function, and reprint the label layout when the error occurs.

4.3 Power-on Utilities

This printer has six power-on functions for setting or testing the printer's hardware. Press these buttons at the same time when the power is turned on, and release the buttons with the light signal to activate these functions.

Follow these steps to enable the boot function:

Event	Description	Status lights	Beep
Self-test	A. Power off the printer B. Make sure the printer is loaded with paper and close the printer cover C. Press and hold the FEED button and turn on the printer. When you hear a beep, release the FEED button. At this time, the printer will print a self-test page.		
Enter USB storage device function	A. Power off the printer B. Make sure the printer is loaded with paper and close the printer cover C. Press and hold the PAUSE button and turn on the printer. When you hear a beep, release the PAUSE button, and the printer's storage device will appear on the computer.		
Enter dump mode	A. Power off the printer B. Make sure the printer is loaded with paper and close the printer cover C. Press and hold the PAUSE and FEED buttons at the same time for two seconds, then turn on the printer's power. When the online Blue and the error Red are on at the same time, release PAUSE and FEED buttons, when you hear a beep, the printer enters the dump mode and will print out "NOW IN DUMP MODE"		
Skip AUTO.BAS	A. Power off the printer B. Press and hold PAUSE and FEED buttons for four seconds at the same time, and turn on the printer power until the power Blue is off, and the error Red is on, release PAUSE and FEED buttons, two beeps are heard. At this time, the printer will skip the AUTO.BAS program, and then the power light is on		
Printer initialization	A. Power off the printer B. Press and hold PAUSE and FEED buttons at the same time for six seconds, and turn on the printer power until the printer online Blue is on and error Red is off, release PAUSE and FEED buttons, five beeps are heard. At this time the printer will restore the printer parameters to the factory default settings		

5. PrinterUtility

Printer Utility is an integrated tool software that helps users query printer settings and status, change printer-related settings, and send commands or files to the printer.

5.1 Start the PrinterUtility

1. Please mouse over Printer Utility icon  Printer Utility.exe image Double click left mouse button.

2. After opening the main screen, you can see the following function items:

- (1) Port Settings
- (2) Printer Information
- (3) Printer Configuration
- (4) Printer Function
- (5) Command Tool
- (6) Language
- (7) About
- (8) Exit

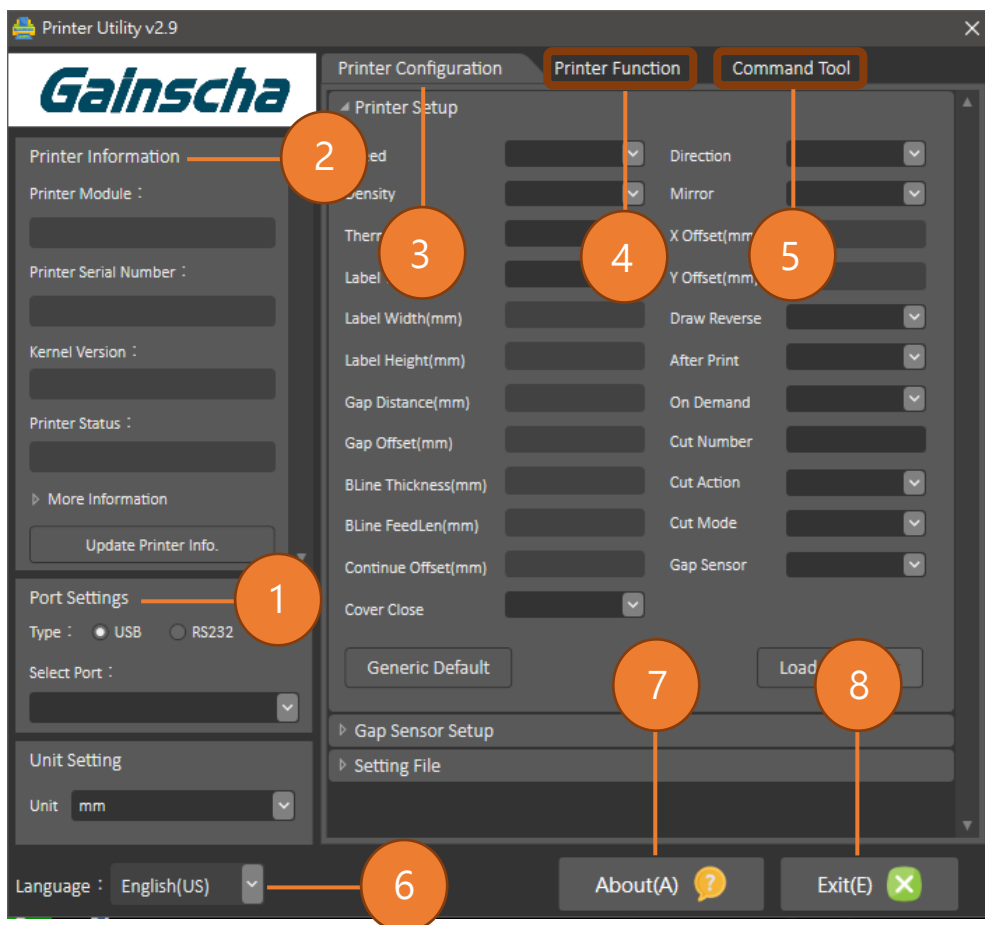

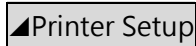

NOTE: If you need more detailed information, please refer to Gainscha official website <http://www.gainscha.com.tw/>

5.2 Printer Function

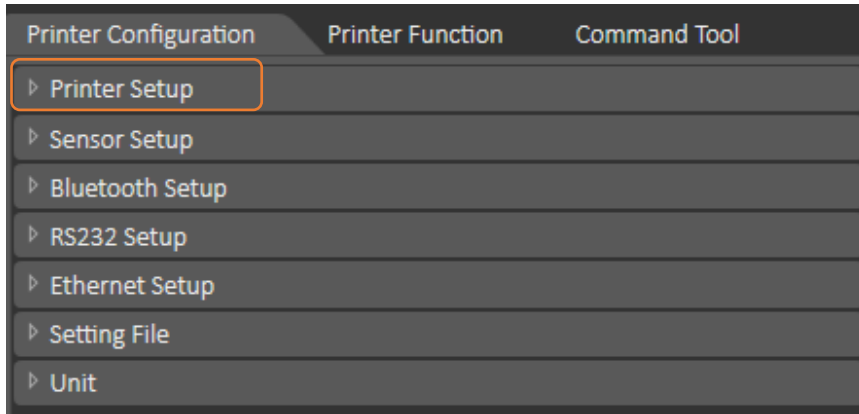
1. Click the  and  Can open and close the printer general settings screen.



2. Click the  Button to bring out all printer general setting information through the selected communication interface. Click the  button to write the setting value to the printer (please execute the reading function before writing).

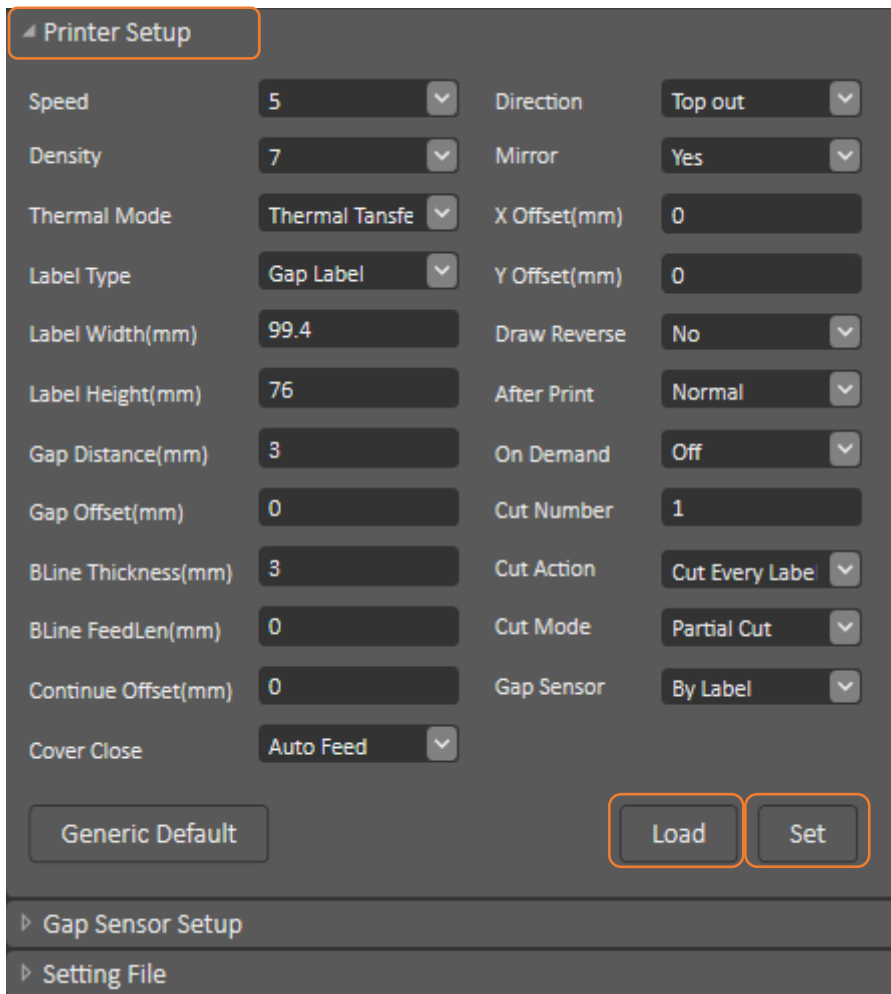

6. Troubleshooting

6.1 Common Problems

The following guide lists the most common problems that may be encountered when operating this bar code printer. If the printer still does not function after all suggested solutions have been invoked, please contact the Customer Service Department of your purchased reseller or distributor for assistance.

Problem	Possible Cause	Recovery Procedure
Power indicator does not illuminate.	<ul style="list-style-type: none"> ● The power cord is not properly connected. ● The printer power switch is not turned on. 	<ul style="list-style-type: none"> ● Plug the power cord in printer and outlet. ● Switch the printer on.
Out of paper	<ul style="list-style-type: none"> ● Out of paper. ● The paper installation path is incorrect. ● Gap / black mark sensor detection is incorrect. 	<ul style="list-style-type: none"> ● Install new paper. ● Follow the steps for installing the paper to reinstall. ● Recalibrate the label sensor.
Paper jam	<ul style="list-style-type: none"> ● Gap / black mark sensor detection is incorrect. ● The label size is set incorrectly. ● Label may be blocked inside the printer. 	<ul style="list-style-type: none"> ● Recalibrate the label sensor. ● Set the correct label size. ● Cleaning the inside of the printer.
Unable to print	<ul style="list-style-type: none"> ● Cable is not well connected to serial or USB interface or parallel port. 	<ul style="list-style-type: none"> ● Re-connect cable to interface. ● Change a new cable. ● Clean the print head. ● The print density setting is incorrect. ● Print head's harness connector is not well connected with printhead. Turn off the printer and plug the connector again. ● Please confirm whether the connection cable of the stepping motor is connected correctly
Poor print quality	<ul style="list-style-type: none"> ● media is loaded incorrectly. 	<ul style="list-style-type: none"> ● Reload the supply.

	<ul style="list-style-type: none"> ● Dust or adhesive accumulation on the print head. ● Print density is not set properly. ● Printhead element is damaged. 	<ul style="list-style-type: none"> ● Clean the print head. ● Clean the platen roller. ● Adjust the print density and print speed. ● Run printer self-test and check the print head test pattern if there is dot missing in the pattern. ● Change proper label media. ● The print head mechanism does not latch the print head properly.
Skip labels when printing	<ul style="list-style-type: none"> ● Label size is not specified properly. ● Sensor sensitivity is not set properly. ● The media sensor is covered with dust. 	<ul style="list-style-type: none"> ● Check if label size is setup correctly. ● Calibrate the sensor by Auto Gap or Manual Gap options. ● Clear the sensor by blower.
The printing position of small label is incorrect	<ul style="list-style-type: none"> ● Media sensor sensitivity is not set properly. ● Label size is incorrect. ● The vertical offset setting in the driver is incorrect. 	<ul style="list-style-type: none"> ● Calibrate the sensor sensitivity again. ● Set the correct label size and gap size. ● If using the software BarTender, please set the vertical offset in the driver.
Missing printing on the left or right side of label	<ul style="list-style-type: none"> ● Wrong label size setup. 	<ul style="list-style-type: none"> ● Set the correct label size.
Wrinkle problem	<ul style="list-style-type: none"> ● Media installation is incorrect. ● Print density is incorrect. ● Media feeding is incorrect. 	<ul style="list-style-type: none"> ● Please set the suitable density to have good print quality. ● Make sure the label guide touch the edge of the media guide.
Gray line on the blank label	<ul style="list-style-type: none"> ● The print head is dirty. ● The platen roller is dirty. 	<ul style="list-style-type: none"> ● Clean the print head. ● Clean the platen roller
Irregular printing	<ul style="list-style-type: none"> ● The printer is in Hex Dump mode. 	<ul style="list-style-type: none"> ● Turn off and on the printer to skip the dump mode.
No print on the label	<ul style="list-style-type: none"> ● Label loaded not correctly 	<ul style="list-style-type: none"> ● Follow the instructions in loading the media

7. Maintenance

This session presents the clean tools and methods to maintain your printer.

1. Please use one of following material to clean the printer.
 - Cotton swab
 - Lint-free cloth
 - Vacuum / Blower brush
 - 100% ethanol

2. The cleaning process is described as following,

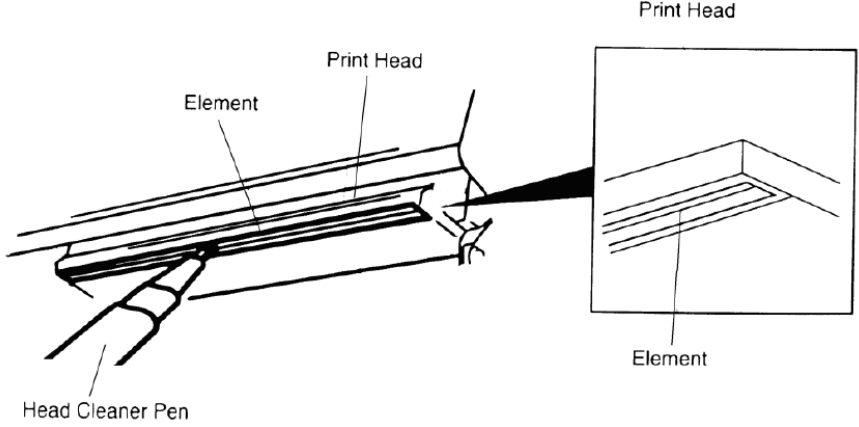
Printer Part	Method
Print Head	<ol style="list-style-type: none"> 1. Always turn off the printer before cleaning the print head. 2. Allow the print head to cool for a minimum of one minute. 3. Use a cotton swab and 100% ethanol to clean the print head surface. <div style="text-align: center;">  <p>The diagram illustrates the cleaning process of a print head. On the left, a 'Head Cleaner Pen' is shown cleaning the 'Print Head' surface. Labels include 'Element', 'Print Head', and 'Head Cleaner Pen'. On the right, a detailed view of the 'Print Head' shows the 'Element' being cleaned. Labels include 'Print Head' and 'Element'.</p> </div>
Platen Roller	<ol style="list-style-type: none"> 1. Turn the power off. 2. Rotate the platen roller and wipe it thoroughly with 100% ethanol and a cotton swab, or lint-free cloth.
Sensor	Compressed air or vacuum
Exterior	Wipe it with water-dampened cloth
Interior	Brush or vacuum

NOTE:

- Do not touch printer head by hand. If you touch it careless, please use ethanol to clean it.
- Please use 100% Ethenol.DO NOT use medical alcohol, which may damage the printer head.
- Regularly clean the print head and supply sensors once change a new ribbon to keep printer performance and extend printer life.
- The maximum printing ratio per dot line is 15% for this printer. To print the full web black line, the maximum black line height is limited to 40 dots, which is 5mm for 203 DPI resolution printer and 3.3mm for 300 DPI resolution printer.

8. Revise History

Date	Version	Content
2020/6/24	Ver.1.0.1	Add chapter 3.4.3 External Label Roll Mount Installation (Option) note.
2020/6/29	Ver.1.0.2	Modify chapter 4.1 LED Indicator.
2020/6/30	Ver.1.0.3	Replace non-conforming drawings and text descriptions. Modify item 3.2,install driver 5th item. Delete chapter 3.3.3 External Label Roll Mount Installation (Option).
2020/8/10	Ver.1.0.4	Modify chapter 4.3 Power-on Utilities
2021/8/26	Ver.1.0.5	Add warning slogan